

6-FM(G)-50Ah

Gel Battery Specification



Application

- Maintenance free
- Safety and no leakage
- Excellent recharge and discharge performance
- Low self-discharge rate
- Adapt to high or low temperature
- Good deep discharge performance
- Longer cycle life



Specification

Rated Voltage	12V
Numbers of cells	6 Cells
Capacity	50Ah@10hr-rate to 1.80V per cell @25°C
Weight	18kg
Internal Resistance	Approx. 7.5 mΩ
Terminal	F1 / F2
Max. Discharge Current	750A(5s)
Short Circuit Current	2500A
Max. Charging Current	12.5A
Reference Capacity	C10 50.0AH C3 43.4AH C1 33.0AH
Design Life	10~15 years
Float Charging Voltage	13.6 V~13.8 V @ 25°C Temperature Compensation: -20mV/°C/Cell
Cycle Use Voltage	14.4 V~14.9 V @ 25°C Temperature Compensation: -30mV/°C/Cell
Operating Temperature Range	Discharge: -20°C~60°C Charge: 0°C~50°C Storage: -20°C~60°C
Normal Operating Temperature Range	25°C±5°C
Self Discharge	Less than 3% at 25°C per month
Container Material	A.B.S. UL94-HB, UL94-V0 Optional.

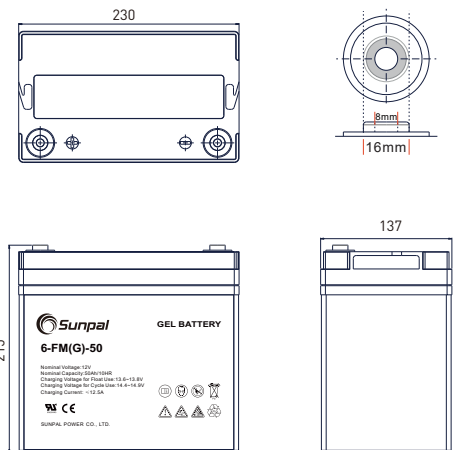

Length	230±2mm (9.1 inches)
Width	137±1mm (5.4 inches)
Height	210±1mm (8.3 inches)
Total Height	215±1mm (8.5 inches)

Constant Current Discharge Characteristics: A[25°C]

F.V/Time	10min	15min	20min	30min	45min	1h	3h	5h	8h	10h	20h
1.80V/cell	93.5	74.4	63.6	45.7	35.8	28.0	13.0	8.55	6.01	5.00	2.68
1.75V/cell	102.8	81.3	68.4	47.4	37.8	29.3	13.3	8.77	6.11	5.05	2.71
1.70V/cell	112.0	86.8	71.9	49.4	38.6	30.2	13.6	8.99	6.20	5.10	2.76
1.65V/cell	120.9	92.3	76.4	52.1	39.6	31.2	14.2	9.20	6.30	5.21	2.79
1.60V/cell	131.3	98.7	81.4	55.0	41.3	32.3	14.6	9.50	6.36	5.26	2.81

Constant-power discharge parameter Unit: W[25°C]1

F.V/Time	10min	15min	20min	30min	45min	1h	3h	5h	8h	10h	20h
1.80V/cell	172.2	138.2	119.4	86.8	68.6	54.0	25.3	16.7	11.9	9.9	5.35
1.75V/cell	186.9	149.5	127.4	89.6	70.9	56.5	25.7	17.1	12.1	10.0	5.40
1.70V/cell	200.8	158.5	133.1	92.9	73.5	57.9	26.3	17.5	12.2	10.1	5.49
1.65V/cell	215.2	167.4	140.8	97.6	75.1	59.6	27.4	18.0	12.4	10.3	5.56
1.60V/cell	229.7	176.9	148.4	102.0	77.5	61.2	28.1	18.5	12.5	10.4	5.58

6-GFM(G)-50Ah

Gel Battery Specification

Charge Characteristics for Float Use @ 25°C/77°F

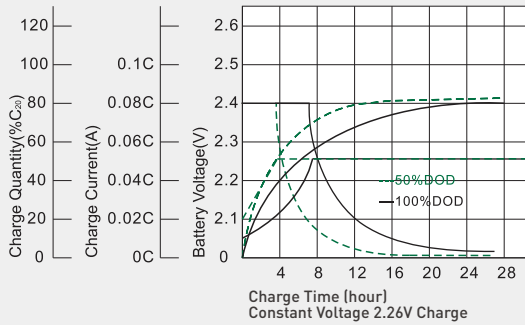

Discharge Characteristics at Various Rates @ 25°C/77°F

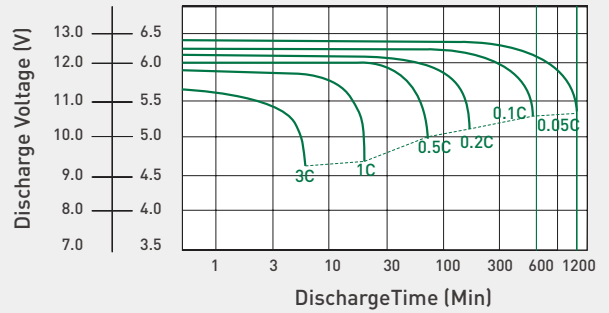

Cycle Life in Relation to Depth of Discharge

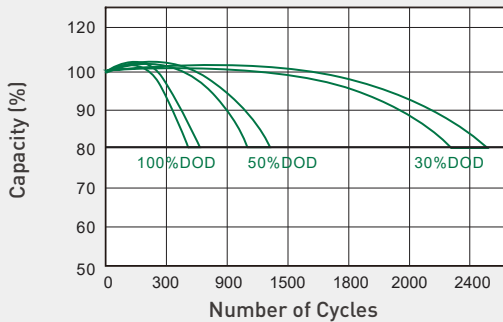

Float Service Life

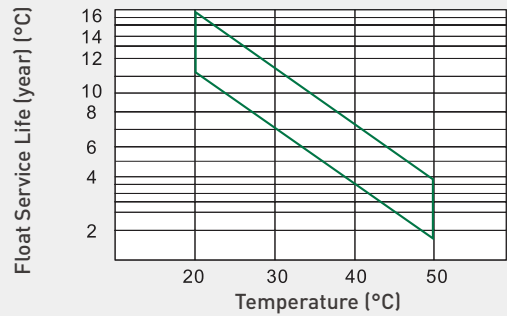

Temperature and Valid Capacity

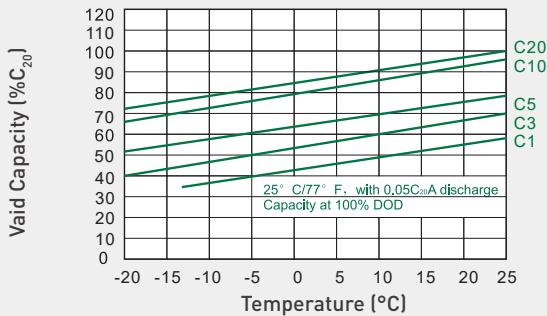

Self Discharge Characteristics

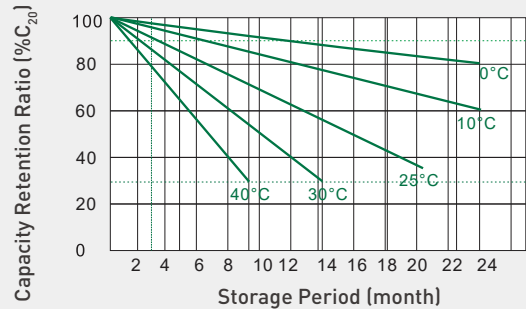

Capacity and Open Circuit Voltage

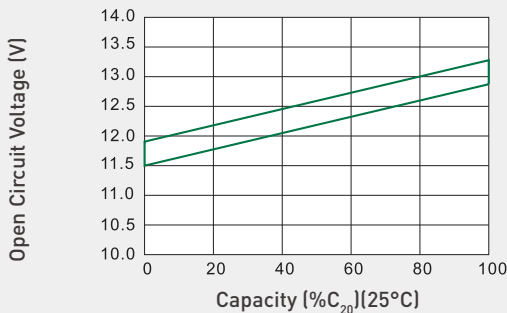

Relationship between Charging Voltage and Temperature

